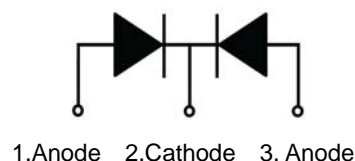
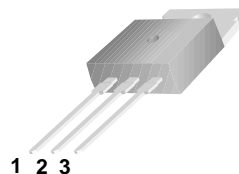

MBR1040CT-MBR10200CT
Features:

- Low power loss,high efficiency.
High surge capacity
- For use in low voltage,high frequency inverters,
free wheeling,and polarity protection applications.
- Metal silicon junction,majority carrier conduction.
- High current Capability,low forward voltage drop.
- Guard ring for over voltage protection.

TO-220

Absolute Maximum Ratings (Ta=25°C unless otherwise noted)

Parameter	Symbol	MBR 1040 CT	MBR 1045 CT	MBR 1050 CT	MBR 1060 CT	MBR 1080 CT	MBR 1090 CT	MBR 10100 CT	MBR 10150 CT	MBR 10200 CT	Unit	
Maximum Recurrent Peak Reverse Voltage	V _{RRM}	40	45	50	60	80	90	100	150	200	V	
Maximum RMS Voltage	V _{RMS}	28	31.5	35	42	56	63	70	105	140		
Maximum DC Blocking Voltage	V _{R(DC)}	40	45	50	60	80	90	100	150	200		
Maximum Average Forward Current	I _{F(AV)}	10									A	
Peak Forward Surge Current:8.3ms single half sine-wave superimposed on rated load (JEDEC method)	I _{FSM}	150										
Maximum Forward Voltage at 5A per leg	V _F	0.65	0.72		0.85			0.92			V	
Maximum DC Reverse Current at Rated DC Blocking Voltage	T _j =25°C	0.1									mA	
	T _j =125°C	20										
Maximum Operating Junction Temperature	T _j	150				175						°C
Storage Temperature	T _{stg}	-55~+150				-65~+175						
Typical Thermal Resistance	R _{θJC}	1.4									°C/W	

Typical Characteristics

RATING AND CHARACTERISTIC CURVES

FIG. 1- FORWARD CURRENT DERATING CURVE

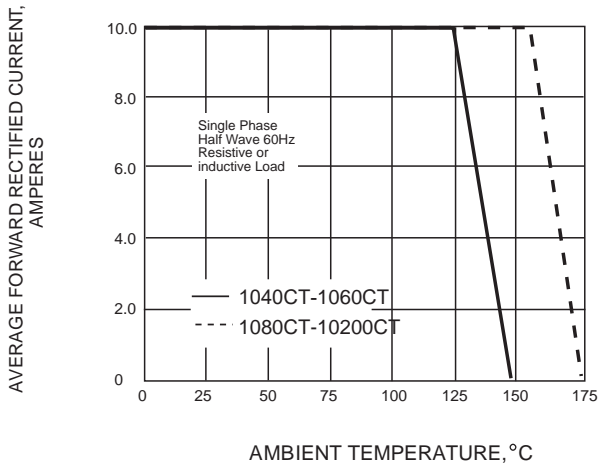

FIG. 2-MAXIMUM NON-REPETITIVE PEAK FORWARD SURGE CURRENT

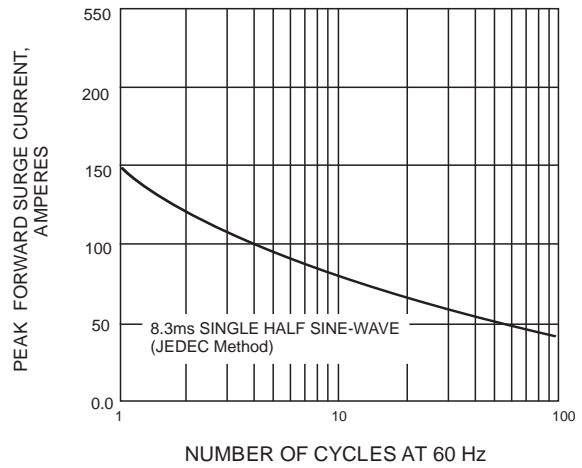

FIG. 3-TYPICAL INSTANTANEOUS FORWARD CHARACTERISTICS

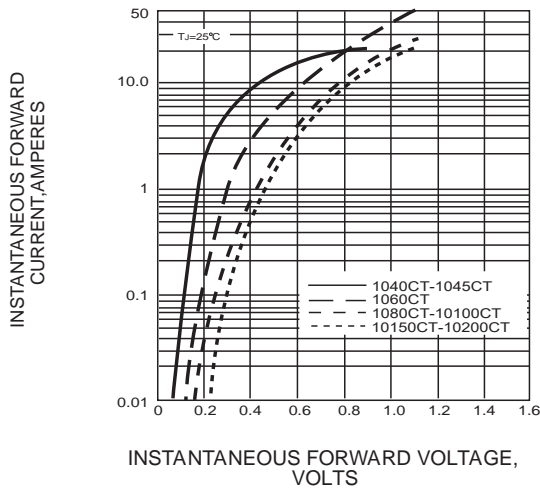
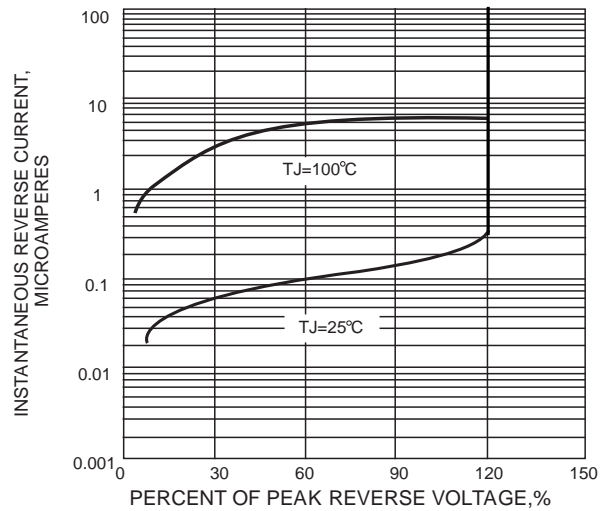
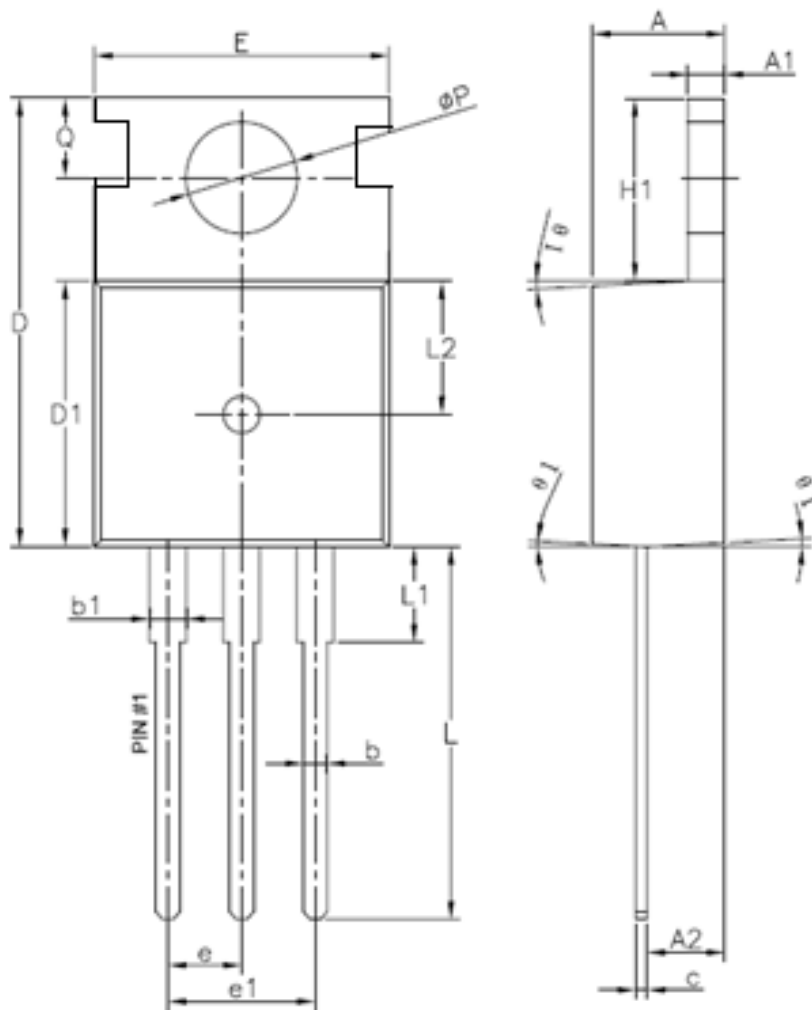

FIG. 4-TYPICAL REVERSE CHARACTERISTICS



Package Dimension
TO-220

Units: mm



Unit: mm

Symbol	Min	Normal	Max	Symbol	Min	Normal	Max
A	4.4	4.5	4.6	e		2.54	
A1	1.27	1.3	1.33	e1		5.08	
A2	2.3	2.4	2.5	H1	6.3	6.5	6.7
b	0.7	/	0.9	L	13.0	13.38	13.5
b1	1.25	/	1.42	L1	/	/	3.5
c	0.45	0.5	0.6	L2		4.6	
D	15.3	15.7	16.1	ΦP	3.55	3.6	3.65
D1	9.1	9.2	9.3	Q	2.73	/	2.87
E	9.7	9.9	10.2	θ1 (°)	1	3	5